

Assembly & Installation Instructions

B310

Oceanus Sconce Single 207693

Page 1 of 3

CAUTION: FAILURE TO INSTALL THIS FIXTURE PROPERLY MAY RESULT IN SERIOUS PERSONAL INJURY OR DEATH AND PROPERTY DAMAGE. We recommend installation by a licensed electrician. This product must be installed in accordance with applicable installation code(s), by a person familiar with the construction and operation of the product and the hazards involved.*

Caution: Do not exceed maximum wattage noted on fixture. Use only recommended bulbs with fixture.

Please Note: This fixture is designed to be mounted on a standard wall surface and may not be suitable for all applications. If installing in a non-wood frame application, we recommend consulting a qualified builder or electrician.

After installation, extra hardware and accessories may be left due to kits being used on multiple products.

Component Parts

A Fixture Front	G Electric Box Cover
B Fixture Back	H Cupped Washer
C Thumb Screws (2)	I Ground Screw
D Wall Mounting Bracket	J Short #8 Black Screw
E Anchors (2)	P Long #8 Black Screws (2)
F #10 Screws (2)	

To Mount Fixture to Wall (Figures 1 & 2)

CAUTION: BE SURE POWER IS OFF AT THE MAIN BREAKER BOX PRIOR TO INSTALLATION.

1. Carefully unpack the fixture from the carton.
2. Fixture front (A) and back (B) are shipped installed. To separate, remove thumb screws (C), and pull apart. Save parts for later use. (Figure 1)
3. Remove short #8 black screw (J) from electric box cover (G) and save for later use. Attach electric box cover (G) to wall mounting bracket (D) using #8 black screw (J). With a pencil, mark the location of all mounting holes in the wall mount bracket (D) on the wall behind.
4. Drill 1/4" holes in the locations marked on the wall. For holes using anchors, place the tapered end of the anchors (E) into the holes and gently tap them flush to the wall using a light weight hammer.
5. Thread the wires in the electrical box through the hole in the wall mounting bracket (D) while moving the bracket into position. Using the 1" #10 screws (F), screw the bracket securely to the wall. Be careful not to over-tighten or strip the anchors.

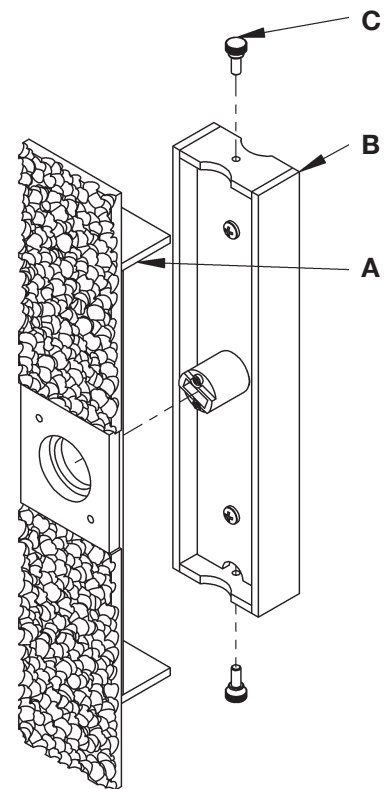

(Figure 1)

(Continued)

If you need further assistance, or find that you are missing any parts, please contact the dealer from which you purchased this product. We hope you enjoy your fixture!

* Hubbardton Forge will not be liable for injury or damage caused by improper installation, lamping or use of this fixture.

Assembly & Installation Instructions

B310

Oceanus Sconce Single 207693

Page 2 of 3

To Mount Fixture to Wall (Figures 2 & 3)

(Continued)

6. Hold the fixture back (B) close to the wall mounting bracket (D) and using suitable wire connectors (not provided) connect fixture wires to supply wires (white to white and black to black). Run a pigtail lead from the ground screw (I) and cupped washer (H) to the electrical box and connect all ground wires (bare copper or green to bare copper or green).

CAUTION: MAKE SURE WIRE CONNECTORS ARE TWISTED ON SECURELY, AND NO BARE WIRES ARE EXPOSED.

7. Carefully tuck all wires behind the fixture back (B) and place over the bracket (D) so the holes in fixture back (B) match the threaded standoffs protruding from the wall mounting bracket (D). Secure by threading the (4) #8 black screws (J) through the holes in the fixture back (B) and into the standoffs on the wall mounting bracket (D).

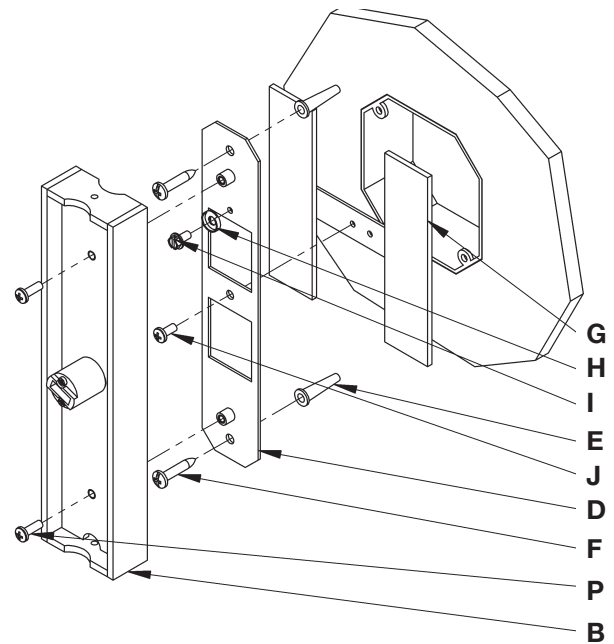

(Figure 2)

To Install Glass (Figure 3)

Component Parts

- A Fixture Front
- K Glass (1)
- L Rubber O-Ring (2)
- M Knurled Ball (2)
- Q Washer (2)

1. Knurled balls (M), rubber o-rings (L), and washers (Q) ship installed. Remove from threaded studs on fixture front (A). Save for later use.
2. Slide glass (K) over end of fixture front (A). Align holes in glass with threaded studs on fixture front (A).
3. Slip glass (K) over threaded studs followed by washers (Q), rubber o-rings (L) and knurled balls (M). Tighten knurled balls (M) to secure glass. Be sure not to over tighten.

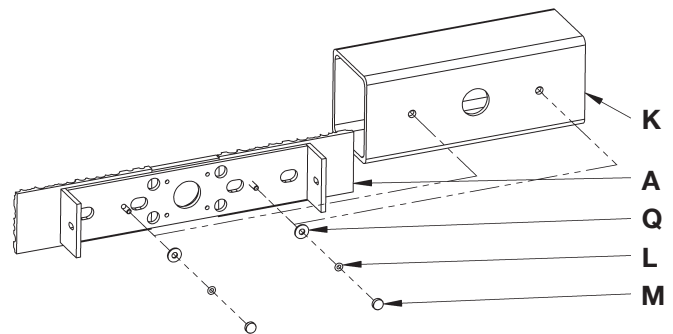

(Figure 3)

(Continued)

If you need further assistance, or find that you are missing any parts, please contact the dealer from which you purchased this product. We hope you enjoy your fixture!

*Hubbardton Forge will not be liable for injury or damage caused by improper installation, lamping or use of this fixture.

Assembly & Installation Instructions

B310

Oceanus Sconce Single 207693

Page 3 of 3

To Complete Fixture Install (Figure 4)

Component Parts

- A Fixture Front
- B Fixture Back
- C Thumb Screws (2)
- N Socket
- O Bulb (Included)

1. Install bulb (O) into socket (N). Be careful not to touch bulb with bare hands; oil from the hands will dramatically reduce bulb life.
2. Slide fixture front (A) over fixture back (B) and fasten with two thumb screws (C).
3. Restore electricity at main breaker.

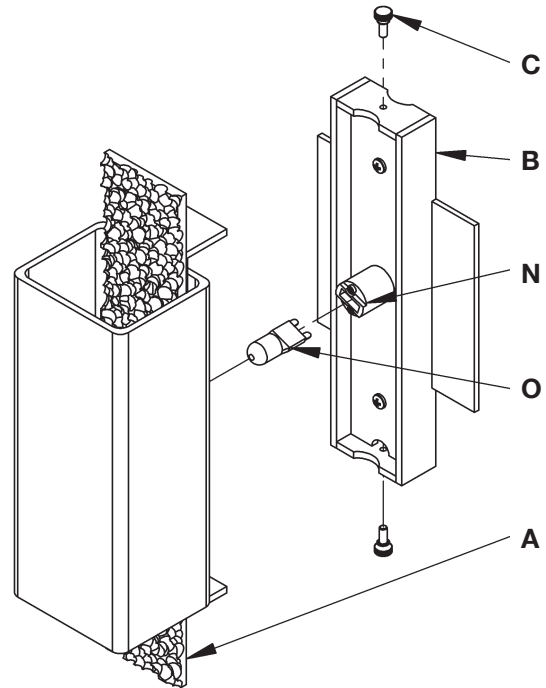

(Figure 4)

If you need further assistance, or find that you are missing any parts, please contact the dealer from which you purchased this product. We hope you enjoy your fixture!

*** Hubbardton Forge will not be liable for injury or damage caused by improper installation, lamping or use of this fixture.**